

Load Monitor system for variable speed drives.

- * Power measurement also after frequency inverters
- * Automatic speed measurement
- * Automatic limit adjustment
- * Two independent limits
- * Two alarm outputs
- * Setup software
- * Analogue output

Load Monitor System APM450

Table of contents

1 System overview	3
2 Application examples	3
3 APM450 - Measuring- and supervision unit	4
3.1 Mounting	4
3.2 Connection	4
3.3 Technical data	4
3.4 Settings	5
3.5 Measuring ranges	5
3.5.1 Voltage range	5
3.5.2 Current range	5
3.5.3 Power range	5
3.5.4 Filters	5
3.6 I/O	5
3.6.1 Analogue outputs	5
3.6.2 Digital inputs	5
3.6.3 Alarm outputs	5
3.7 LED indicators	5
4 Supervision functions	6
4.1 Automatic activation / deactivation	6
4.2 Limits	6
4.2.1 Max. limit	6
4.2.2 Min. limit	6
4.3 Setpoint adjustment	6
4.3.1 Speed measurement	7
4.4 Blocking the supervision	7
4.4.1 External blocking	7
4.4.2 df/dt blocking	7
4.5 Supervision curve	8
4.5.1 Changing the supervision curve	8
4.6 Arranging the supervision system	9
5 Setup utility software VFDSsetup	10
5.1 System requirements	10
5.2 Installation	10
5.2.1 Download	10
5.2.2 CDROM	10
5.3 Setup	10
5.4 File	10
5.5 Communication	10
5.6 Parameters	11
5.6.1 Measuring range	11
5.6.2 Timers	11
5.6.3 Limits	11
5.6.4 Frequency settings	11
5.6.5 kWh settings	12
5.7 Curve	12
5.7.1 Modify curve	12
5.7.2 New curve (F8)	13
5.7.3 Stop at alarm (F9)	14
5.8 About	14
5.9 The main window	15
5.9.1 Roll window	15
5.9.2 Menu	15
5.10 Keyboard commands	15
5.11 Shortcuts	15
5.12 Error messages	15

1 System overview

The APM450 makes it possible to monitor and supervise applications running at variable speeds either driven by variable speed drives or variable gearing. The basic function is to perform an over- and underload detection for protection of the driven machine. The torque M_d delivered by the motor is

$$M_d = P \times 60 / 2\pi \times n$$

The torque is a function of the speed of the motor and therefore the limits must be adjusted according to the speed.

The unit thus measures and monitors the electrical power consumption and also the frequency of the motor. The power measurement is performed after the principle described by the following formula:

$$P = \sqrt{3} \times U \times I \times \cos\varphi$$

Measuring after frequency inverters is done in the frequency range from 10Hz up to 150Hz. The frequency is either measured internally or supplied by an external signal.

To be able to use the unit with success it is important to record a Power/Frequency curve for the machine under normal load conditions. An example is shown in Fig.1 below.

This document is divided into 3 main sections:
Sec. 3 explains the hardware and the connection of the unit.
Sec. 4 explains in details the strategy for the supervision and also how to obtain the curve and how to modify the limit curve etc.
Sec. 5 explains the use of the Setup Software, **VFDSetup**.

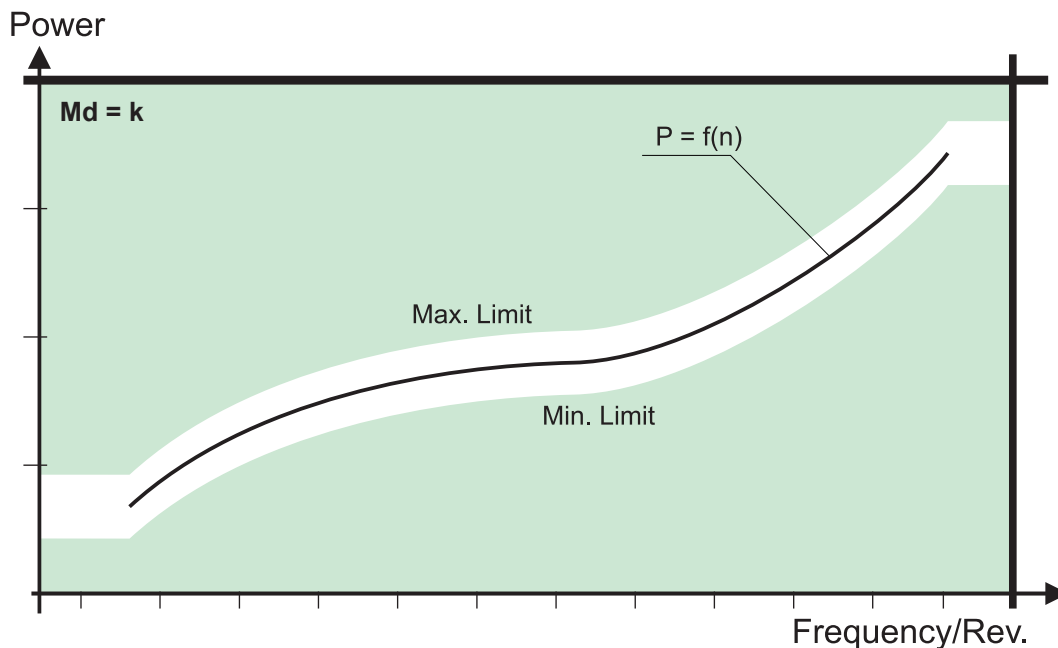

Figure 1. Frequency dependent load curve

2 Application examples

Typical applications for the APM450 system are installations with variable rpm. These include:

- * Pumps
- * Conveyor systems
- * Mixers
- * Cranes

3 APM450 - Measuring- and supervision unit

The unit APM450 includes the complete hardware for measurement and supervision with the technical specifications shown to the right. The setup / record of the supervision reference curve as well as the presentation of the supervision state is performed by the setup software VFDSsetup via a serial RS232 connection.

3.1 Mounting

The APM450 is mounted on a DIN rail. Current measurement requires the supply lines to the motor to be feed through the tubes in the unit - see figure 3.1.

3.2 Connection

Connecting the APM450 is done in direct connection with the motor as shown in figure 3.1. The motor may thus be driven either directly from the mains or by a frequency inverter. The APM450 requires an external 24Vdc supply.

3.3 Technical data

Mechanical

Housing: Lexan UL94V-0 (Top)
Noryl UL94V-0 (Bottom)
Mounting: M36 for 35 mm DIN rail
IP class: Housing IP40. Terminals IP20
Terminals: Max 16A. Max 2,5 mm²
Terminal tight. torque: 7lbs/in, 0.79Nm
Use 60/75 copper (CU) wire only
Opp. Temp.: -15 to +50 °C surrounding air
Weight: 300 g
Dimens.: D 58 x W 102 x H 86 mm
CE mrk: EN61326-1, EN61010-1
UL certified: UL508, File E350194

Electrical

Supply: 24Vdc ±10%, max 150mA
Voltage range: 3x230V - 3x575V
Current input: Max. 30A
Power range: Max 30kW
Frequency range: 10 Hz - 150Hz
Accuracy: Class 2%
Analogue output 1: 0(4)-20 mA max 300Ω
Analogue output 2: 0(2)-10V min load 10kΩ
Digital inputs: 12 - 24V DC
Digital outputs: Optocoupler, max. 30V/30mA
Serial port: RS232C, 14400 Baud

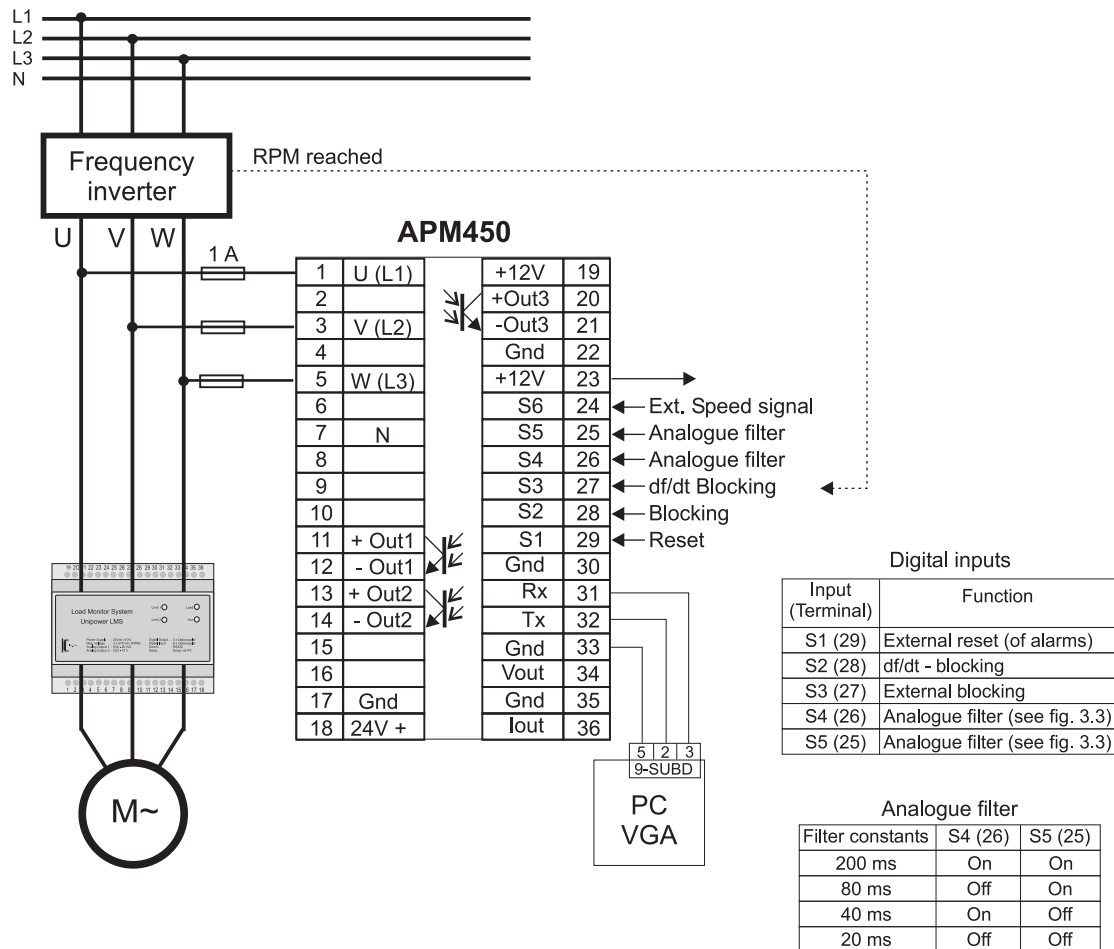

Figure 3.1 Connections

3.4 Settings

All parameters for the APM450 are set up from a PC with the help of the setup software VFDSetsup via a serial RS232 interface (See chapter 5 - Setup software). The settings are automatically stored in the unit. For later use or for use in a new unit all settings may be stored on the PC.

3.5 Measuring ranges

3.5.1 Voltage range

In order for the unit to measure the voltage correctly all three phases must be connected directly to the unit (connectors 1/3/5). The unit is applicable for voltages in the range from 3 x 230 - 3 x 575V as well as after frequency inverters.

The voltage range must be set up in the PC software before correct measurement can be performed since it is used for computing the power range. If using a frequency inverter please use the input voltage for the inverter as voltage range.

3.5.2 Current range

The current measurement is performed with three internal current transformers mounted around the three tubes going through the unit. Therefore the supply wires for the motor must be feed through the APM450. The phase order must be the same as for the voltages. The direction of the current is not important - must be the same for all three though.

The internal current range is automatically selected on the basis of the entered voltage- and power range. The maximum current range is 30A.

3.5.3 Power range

The power range is selected in Startup in the VFDSetsup. It forms the basis together with the selected voltage range of determining the internal current range. The power range may be chosen in the range from 0,1kW up to 29,8kW depending on the chosen voltage range. The following table shows the maximum power range for each nominal voltage.

Voltage	Power range
230 V	11.9 kW
380 V	19.7 kW
400 V	20.7 kW
415 V	21.5 kW
440 V	22.8 kW
460 V	23.8 kW
500 V	25.9 kW
575 V	29.8 kW

Figure 3.2 Power ranges

The chosen range corresponds to 100% in the supervision range - i.e. 20mA or 10V on the analogue output.

3.5.4 Filters

The measurement as well as the calculation of the power values in the APM450 is performed at a rate which may make it necessary to smooth the measured signals if they fluctuate too much. This may be done using the build-in

analogue filters which are selected via two digital inputs (S4 and S5). The following table shows the filter constants as well as the inputs used to select them.

Filter constants	S4 (26)	S5 (25)
200 ms	On	On
80 ms	Off	On
40 ms	On	Off
20 ms	Off	Off

Figure 3.3 Analogue filters

3.6 I/O

3.6.1 Analogue outputs

The APM450 includes two analogue outputs, which reflect the measured and possible filtered load. Hence the entered power range corresponds to 20mA and 10V. The outputs may be setup as 0(4) - 20mA and 0(2) - 10V. It is not possible to have 4-20mA and 0-10V at the same time, since the voltage signal is derived from the current signal.

3.6.2 Digital inputs

Via the digital inputs S1 - S5 various functions may be preset or controlled during operation. The inputs are activated by a voltage from 12-24Vdc.

Input (Terminal)	Function
S1 (29)	External reset (of alarms)
S2 (28)	df/dt - blocking
S3 (27)	External blocking
S4 (26)	Analogue filter (see fig. 3.3)
S5 (25)	Analogue filter (see fig. 3.3)

Figure 3.4 Digital inputs

3.6.3 Alarm outputs

Two opto coupler outputs serve as alarm outputs reflecting the status of running supervision. Output 1 (Out 1) is controlled by the max. limit and output 2 (Out 2) by the min. limit (see figure 3.1).

3.7 LED indicators

Four LEDs on the front plate signals to the user the status of the underlying supervision. The following table shows how.

LED	Blinking	Lit
Load	Supply voltage present, Load below 5% of power range	Load > 5%, Supervision active
Aux	-	Blocking active
Limit 1	Limit 1 alarm (Max. alarm)	Setpoint 1 exceeded Tr 1 active
Limit 2	Limit 2 alarm (Min. alarm)	Setpoint 2 exceeded, Tr 2 active

Figure 3.5 LED indicators

4 Supervision functions

The APM450 includes a max.- and a min. limit for supervision of the measured load. The setpoints are stored in form of a speed dependable load curve and are controlled by the measured frequency (speed).

4.1 Automatic activation / deactivation

A startup of the driving motor is detected by the APM450 through a rise of the measured power consumption; When the measured load reaches the activation threshold of 5% of the entered power range, the start timer T_s is activated (1). After expiration of this timer all supervision functions are made active (2) - see figure 4.1.

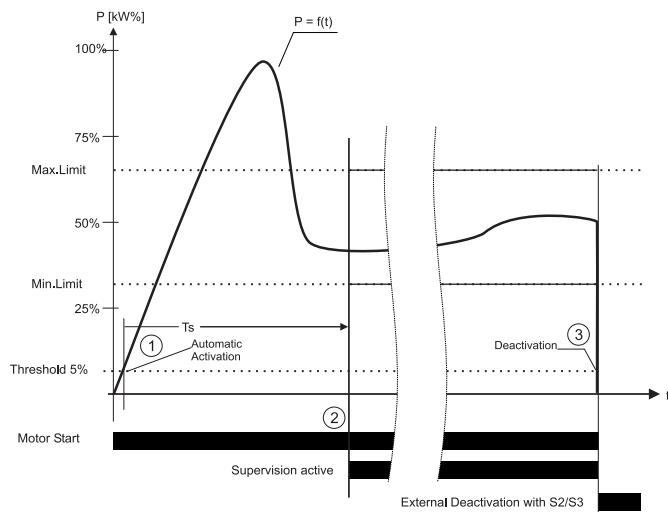

Figure 4.1 Activation / deactivation

If a min alarm must be avoided when stopping the motor intentionally (3), the supervision must be disabled either by activating one of the two blocking inputs (S2/S3) - see chapter 4.4 - or by using the automatic df/dt blocking.

By automatic df/dt blocking the unit detects the frequency change and blocks the supervision.

Note! When using the automatic df/dt blocking special attention must be given the respons times at low frequency; Fast respons times may result in faulty alarms due to slow frequency changes.

4.2 Limits

The two limits (max. and min.) are independent of each other and may be disabled if needed without one having influence on the other.

After measuring the reference points (curve) the system automatically places the setpoints of the limits 10% above for the max. limit and 10% below for the min. limit. These values may later be placed manually to suit the actual application.

The value of the actual setpoint is automatically computed on basis of the currently measured frequency and the stored reference curve - see paragraph 4.3.

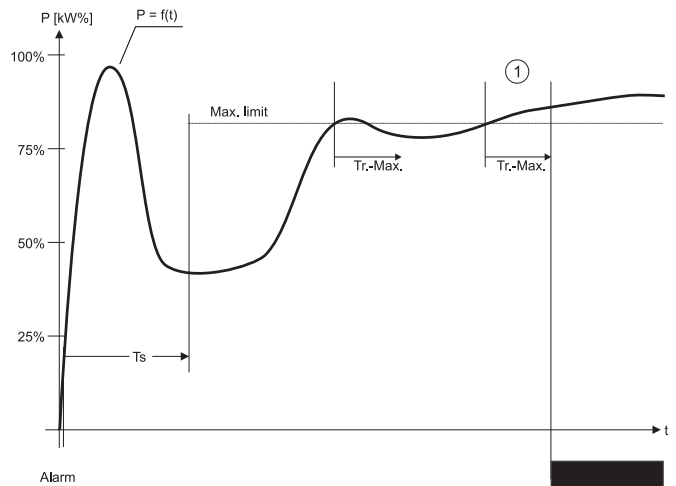

Figure 4.2 Functionality of the max. limit

4.2.1 Max. limit

The max. limit serves as over load protection of the driven equipment. The setpoints are set in % of the entered power range. Individual respons timers are available for each limit. If the setpoint for the max. limit is exceeded continuously for the duration of the respons time (T_r Max) a max. alarm is given (1) - see figure 4.2.

4.2.2 Min. limit

With the min. limit an underload protection of the driven equipment is performed. As for the max. limit the setpoints are set in % of the entered power range. If the setpoint for the min. limit is exceeded (measured value less than setpoint) continuously for the duration of the min. respons time (T_r Min) a min. alarm is given (1) - see figure 4.3.

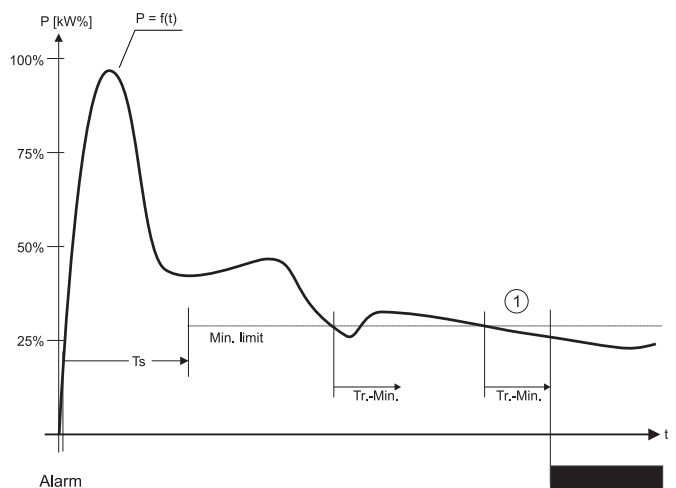

Figure 4.3 Functionality of the min. limit

4.3 Setpoint adjustment

In applications using variable speed it is necessary to adjust the setpoint for the limits depending on the actual speed. The APM450 is especially developed for this purpose and is thus equipped with a number of dedicated functions to realize this task. Figure 4.4 shows an example on how the setpoints change when the speed of the application changes.

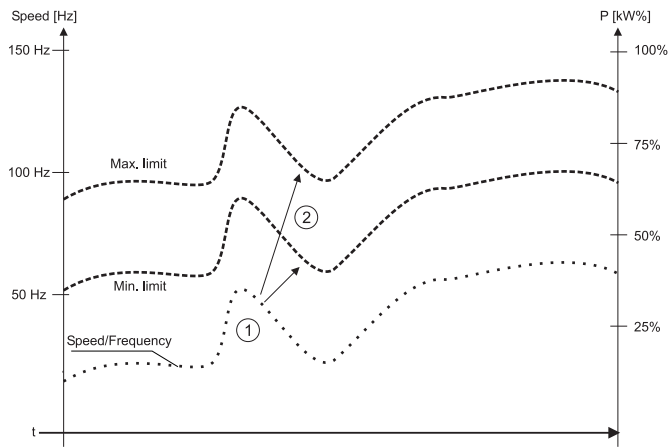

Figure 4.4 Setpoint adjustment

4.3.1 Speed measurement

The necessary adjustment of the setpoints happens depending on the actual speed, which may be measured in one of two ways: External signal via digital input or automatically (direct measurement).

The speed is measured in the range from 10Hz up to 150Hz. Only frequencies in this range may be used to adjust the setpoints.

External speed signal

Using an external signal as basis for the frequency measurement requires a square wave signal connected to digital input S6 (24). The APM450 is able to measure external square wave signals with frequencies up to 2.25 kHz. If the signal exceeds 150Hz it must be divided to fit into the 10-150Hz range. For this purpose a divider with a factor up to 15 is available.

The external signal may come from a speed output of the frequency inverter or from another source.

Automatic / Direct measurement

A build-in circuit enables a direct measurement of the frequency and thereby an automatic detection of the actual speed. This way it is possible to realize a speed dependent supervision without external speed signals. This, however, is only applicable when using a frequency inverter as variable speed drive - not when using mechanically variable transmissions.

4.4 Blocking the supervision

The supervision may be blocked (disabled) in various ways. The measurement continues during the blocking - setpoint excesses no longer results in alarms though.

4.4.1 External blocking

Whenever it for application specific reasons may be necessary, the supervision may be blocked using the digital input S2 (28). The supervision remains inactive as long as the digital input S2 is activated. The following figure 4.5 shows an example of the use of external blocking due to an expected rise in the load of the motor. When the expected load disappears again the input S2 is deactivated and supervision is continued.

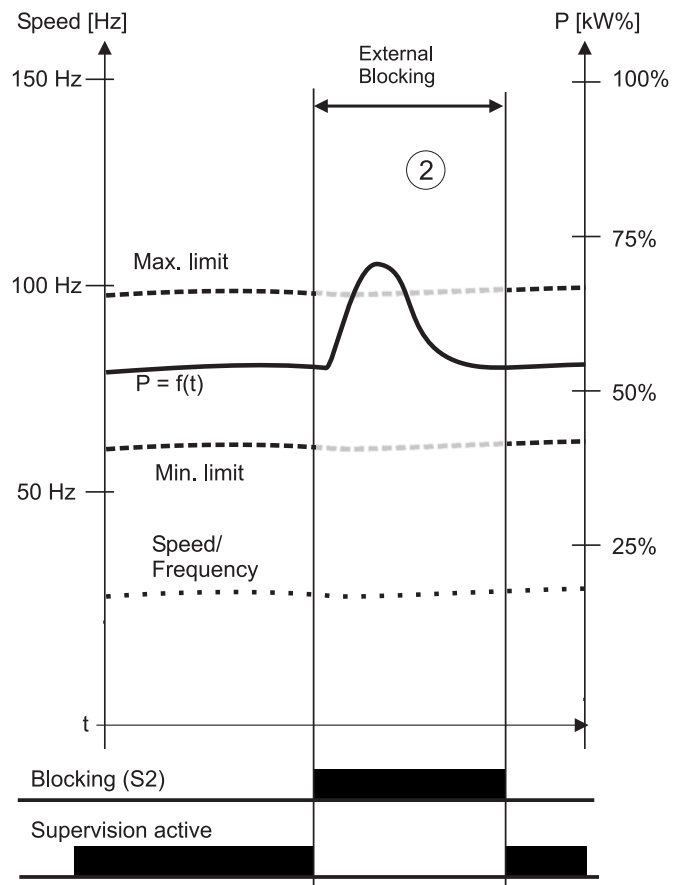

Figure 4.5 External blocking (S2)

4.4.2 df/dt blocking

Accelerating the driving motor requires overcoming the inertia, which draws a lot of energy from the supply. This results in a sudden rise in power with an excess of the max. limit as a result - i.e. a max. alarm. The opposite happens when the motor decelerates - now kinetic energy is available resulting in the motor drawing less or no energy from the supply - i.e. a min. alarm occurs.

During these periods of time supervision is not desirable and must be deactivated to avoid false alarms.

Automatic df/dt blocking

The APM450 is able to block the supervision automatically during changes in speed ($\pm df/dt$). If the speed changes with a certain dynamic the change will be detected (1) and the supervision is deactivated (blocked) (2) - see figure 4.6.

The sensitivity of the automatic blocking may be set in 10 steps. The lower value the more sensitive the blocking will be. Duration of the blocking after a change is detected may be set from 0 to 25 seconds (Blocking time T_b). During this time the blocking is held. If a new change is detected before the blocking time is expired a new blocking time is initiated.

Note! Much care must be taken when using this feature, since frequency changes may appear to happen at random due to unforeseen external events and may thus result in false alarms - or worse - false blocking of the supervision.

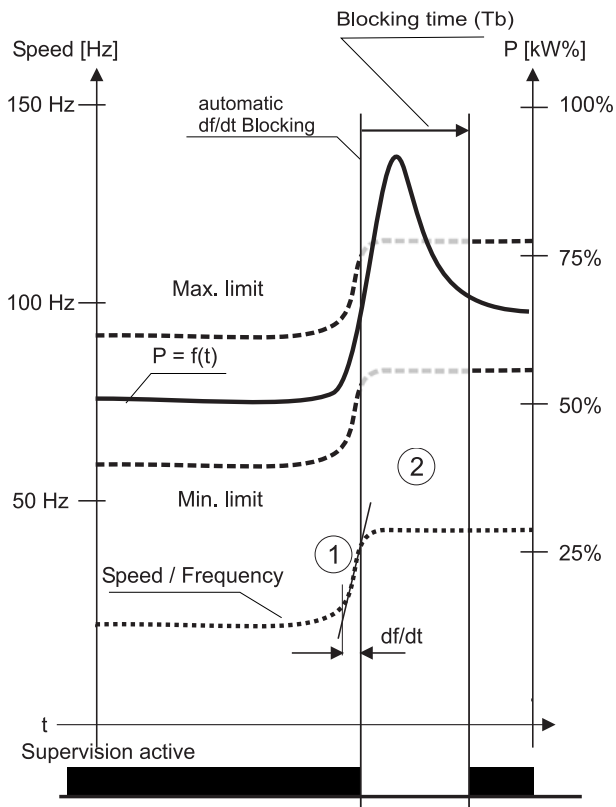

Figure 4.6 Automatical df/dt blocking

Controlled df/dt blocking

Via the digital input S3 (27) the supervision may likewise be disabled externally. This may be done for instance using a signal from the frequency inverter telling that the speed is reached. The supervision remains disabled as long as the input S3 is active but may be extended with the blocking time Tb (2) - see figure 4.7.

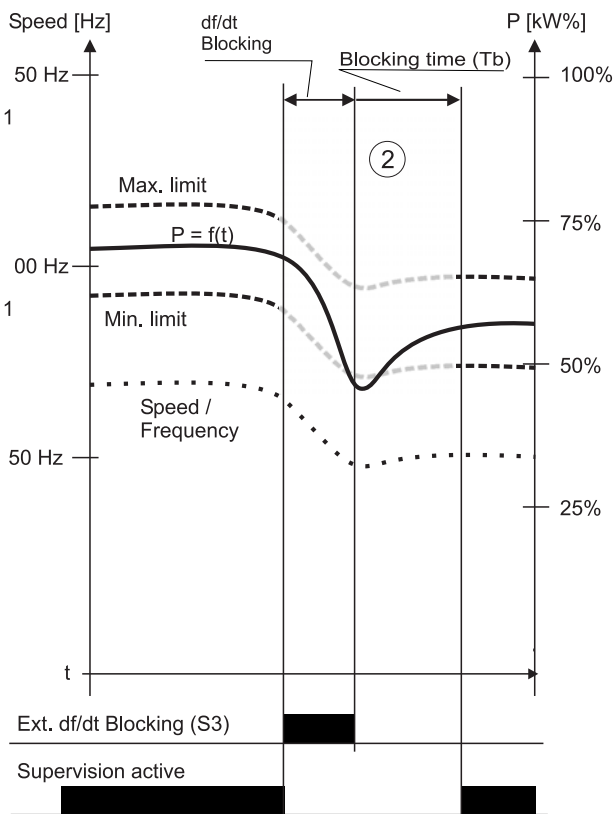

Figure 4.7 Controlled df/dt blocking (S3)

4.5 Supervision curve

Supervising a speed variable application requires a special supervision curve fitted to a characteristic load course of the application. The actual setpoints are adjusted in real time to fit this curve on the basis of the current speed measurement. The characteristic load curve will for this purpose be stored in the APM450.

The basis for the supervision curve is between two and ten recorded measurements $P=f(n)$. These measurements (points) are linearly interpolated by the software and encompassed with a max. and min. limit band (1) (see figure 4.8).

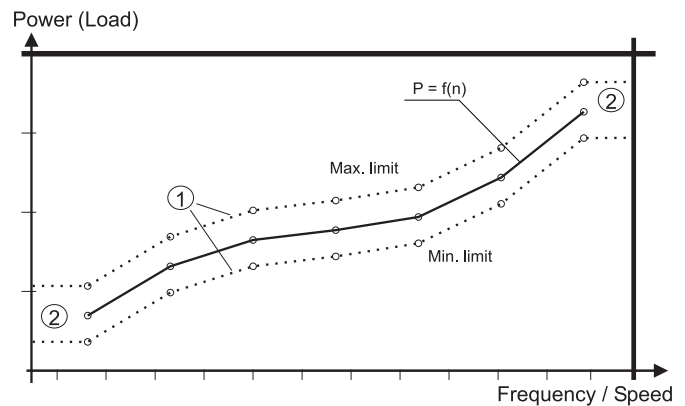

Figure 4.8 Supervision curve

The measured points may be obtained through practical recording of the application behaviour during a test run (Measure curve) or theoretical through construction of a curve on a PC (Make curve).

Upon recording the system automatically places a setpoint band around the curve with a distance of $\pm 10\%$ of the measuring range. The band will equal the highest value (load) for frequencies above the highest frequency and equal the lowest value for frequencies below the lowest frequency (2) - see figure 4.8.

The response times for both the max. and the min. limit equals the general response time set up before recording of the reference curve began. These values may be changed later - see next paragraph about changing the supervision curve.

4.5.1 Changing the supervision curve

The automatically placed setpoint band may subsequently be fitted to suit the application - see figure 4.9.

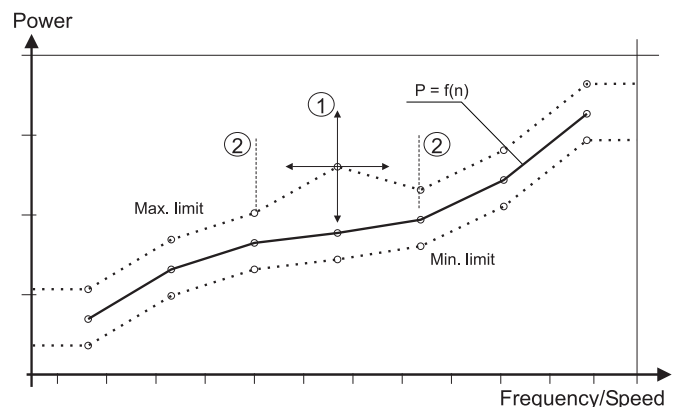

Figure 4.9 Refitting the setpoints

Setpoint and frequency

Each setpoint is movable vertically (Power value) and horizontally (Frequency value) (1) - see figure 4.9. The Power value may be chosen freely in the range of 0-100%. The frequency value - however - must lie between the frequency values of the setpoint before and after (2).

Response time

Each setpoint may be assigned its own response time different from the general setting. Between each setpoint the response time will be linearly interpolated (1) - see figure 4.10.

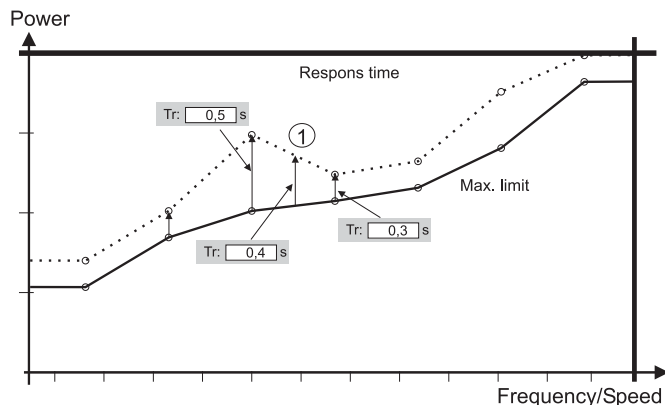

Figure 4.10 Changing the response time

4.6 Arranging the supervision system

Arranging and possible future changes to the supervision system is done with the PC software VFDSsetup. Using the software and its functionality is described in chapter 5.

When installing a supervision system like APM450 for the first time it is recommended to proceed according to the following basic scheme.

System values

For the correct setup of the system it is necessary to know the upper and lower points of supervision of the application. Especially the power range, frequency range and voltage range are key values when setting up the APM450; These values fix the working range of the system and can not be changed after recording of a supervision curve. If they need to be changed at a later stage all settings must be discarded and a new supervision curve must be recorded.

Installing the software

All settings of the APM450 are set / changed with the software VFDSsetup. Installing the programme follows from the supplied CD in a directory of the user's choice.

The APM450 is connected to the PC via a RS232 connection. Upon successful installation and optimization of the system this connection may be removed and the APM450 continues to work as a stand-alone system.

Selecting a curve

The entry to selecting a curve is via the menu „Curve“ followed by „New“ (F8). Here it must be decided how a new curve must be made or from where it must be loaded. The

following options are available:

- Measure curve
- Make curve
- Import curve from file
- Import curve from APM450

Basic setting

Before recording / construction of a curve can be done, the basic system values and parameters must be entered.

ID

To identify the supervision curve an ID of up to 30 characters may be chosen.

Setpoints (Only valid for construction of a curve)

Number of points of which the curve must be constructed of. At least 2 and not more than 10.

Voltage

Nominal voltage of the application. When using a frequency inverter the supply voltage of the inverter must be selected.

Measure curve (Record)

Using this function the actual power values of the application may be measured (recorded) to form the basis of the supervision curve. Up to 10 points (Power, frequency) may be recorded and at least two must be used. Upon recording the curve will be encompassed by a max.- and a min. limit band (see paragraph 4.5).

Optimizing the curve

Upon recording / construction of the curve the user most likely needs to optimize the limit bands. This feature is also available at any future point in time without having to record a new curve (see paragraph 5.7.1).

Load and save

A supervision curve with corresponding parameters / settings may be saved on disc under a user selectable file name and loaded at a later time to either form the basis of a new curve or as an exact copy for a similar application. Loading a curve transmits all settings to a connected APM450.

All functions available in the VFDSsetup software will be described in detail in the following chapter.

5 Setup utility software VFDSetup

The VFDSetup programme is made for setting up of the advanced load control APM450. The software is Windows based and has the following system requirements:

5.1 System requirements

Processor: Pentium P4
Harddisc: Min. 3Mb free disc space.
COM-port: 1 available RS232-port. Max. COM8.
The Baud rate is automatically set to 14400 baud
Monitor: Min. resolution 1024x768.
Operating system*:
Windows 2000 SP4
Windows XP SP2
Windows Vista
Windows 7
Windows 8, 8.1
Windows 10

*If the operating system is older, the .net framework version 2.0 probably needs to be installed separately. Please refer to the Microsoft Download Center (www.microsoft.com/downloads) for how to acquire and install the framework.

5.2 Installation

The software may be supplied in various ways; on CDROM together with the APM450 or from the manufacturer's website: www.unipower.dk. The installation procedure depends on the media.

5.2.1 Download

Save or execute the downloaded file „Setup.exe“ and follow the installation procedure, which automatically installs the software and creates the necessary directories and shortcuts. This way all data is stored with the VFDSetup software and is easy to find.

5.2.2 CDROM

If the installation does not start automatically, run „CD_Start.exe“ from the CDROM and follow the installation programme.

5.3 Setup

The software supports the construction of a speed dependable limit window with max.- and min. limit as well as corresponding response times. Furthermore the actual settings of the unit (APM450) may be shown and changed if required. All settings are stored in the APM450 and remain valid after loss of supply voltage.

The used supervision curves and settings may also be saved on the PC and as required reused or transferred on to another APM450.

Starting up the VFDSetup software produces the window shown in figure 5.1 until a valid connection between the PC and the APM450 has been established. If for some reason the connection is lost the software returns to showing the

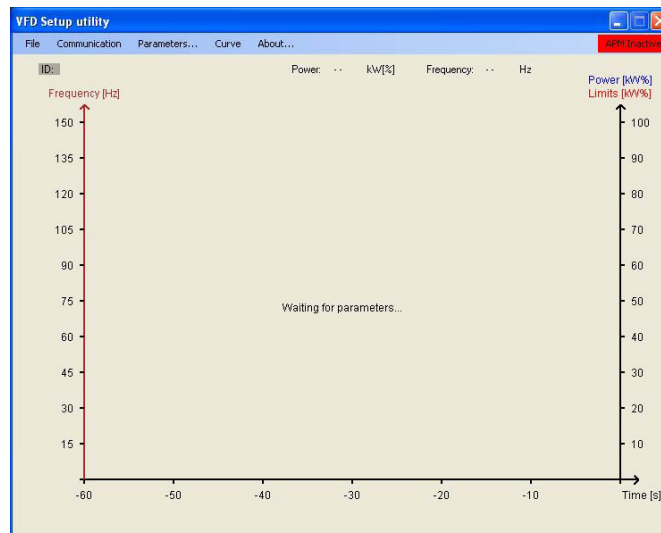

Figure 5.1 No connection to APM450 window shown in figure 5.1 telling the user that no data is received from the unit. Also the status field „APM inactive“ will appear in red on top of the display.

5.4 File

Save (F2)

A present supervision curve may with this menu entry be saved under a user selectable file name for future use or backup.

Exit (Alt+X)

Shuts down VFDSetup (Has no influence on already transferred settings to APM450)

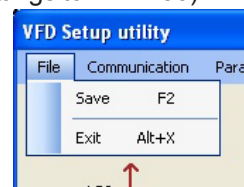

Figure 5.2 File menu

5.5 Communication

Establishing a connection is done by connecting the APM450 to an available COM port on the PC and then selecting this COM port in the software via the menu under „Communication“ - see figure 5.3. Only the available COM ports are selectable in the drop down menu. Others are „grayed“. If the port is unknown to the user VFDSetup is able to search for the APM450, if only the unit is connected to an available COM port. This function is activated with „Auto connect“ under „Communication“ - see figure 5.3.

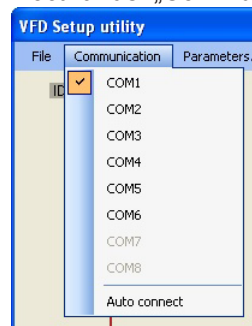

Figure 5.3 Selecting COM-port

5.6 Parameters

The dialogue box with general settings contain parameters for measuring range, general timers as well as special frequency features (see figure 5.4). A description of each parameter follows. Note that the range parameters can not be changed if called directly from the menu („Parameters...“) - as seen in figure 5.4. This is done to prevent a mismatch to the underlying curve.

Figure 5.4 General parameters

ID: A user defined ID may be entered to identify the set of parameters and curves. This ID may be up to 30 characters long.

5.6.1 Measuring range

Voltage Range: Nominal voltage for the application (Supply voltage for the frequency inverter - if used)

P1Max: Power Range (P1) in kW in which the curve will be recorded. This range is set to 100% and can not be changed later. If another range is needed a new curve must be recorded.

Note! When selecting the power range make sure to select it so large that also the max. limit lies within.

The power range will be used by the software to calculate the internal current range.

5.6.2 Timers

Start Time: Timer to block for alarms during start of the motor. It must be large enough to allow the motor to reach operating speed before it expires.

Respons time Max: General setting for respons timer for the max limit. Individual settings for each point on the curve may be entered later. If this value is changed, all points for the max limit are set to this value.

Respons time Min: General setting for respons timer for the min limit. Individual settings for each point on the curve may be entered later. If this value is changed, all points for the min limit are set to this value.

5.6.3 Limits

Limit 1 (Max): Enable / disable the max limit. If disabled the curve will no longer be visible in the roll window.

Limit 2 (Min): Enable / disable the min limit. If disabled the curve will no longer be visible in the roll window.

5.6.4 Frequency settings

Frequency input: Determines whether frequency is measured automatically (Internal) or externally via digital input S6 (See paragraph 4.3.1).

Divider: If frequency is measured via digital input S6 (External) a divider may be needed to fit the measured frequency into the allowed range (10-150Hz). Dividing is done using integers selectable from 1 to 15, so the displayed frequency may not necessarily represent the actual frequency. This is not important though, since it only acts as a reference for the limit curves and will be used the same way during curve building as well as in normal operation.

df/dt blocking: Select blocking of limits during frequency changes - externally via digital input S3 or automatically.

Blocking time (Tb): Time after a frequency change has occurred (external or automatic) during which both limits are disabled. Blocking time is selectable in the range 0.0 - 25.0 sec. If using external blocking (S3) the blocking timer is started when the external blocking signal is removed and will thus be used as extension.

df/dt: Frequency change which must occur before blocking time is started. df/dt is only available during automatic detection. The smaller the df/dt value the more sensitive the blocking will be.

Pressing „Cancel“ returns to the roll window and all changes are discarded. To keep the changes press „Continue“. Depending on the process initiated the programme proceeds with „Measure curve“ (chapter 3.6) or „Change setpoints“

(chapter 3.7) or simply returns to the roll window.

5.6.5 kWh settings

A feature for integrating energy consumption is included in the APM450. The total kWh count is displayed in the parameter window and may be reset from the PC. Doing so produces a warning, which must be acknowledged before an actual reset is performed.

The limit settings are not yet defined and therefore not selectable. A later version may include this feature.

5.7 Curve



Figure 5.5 Curve menu

5.7.1 Modify curve

The window for changing setpoints is shown in figure 5.6. The curve shown in this window is the curve used for the actual supervision. Here the measured curve is shown in red and the max- and min limits are shown in black.

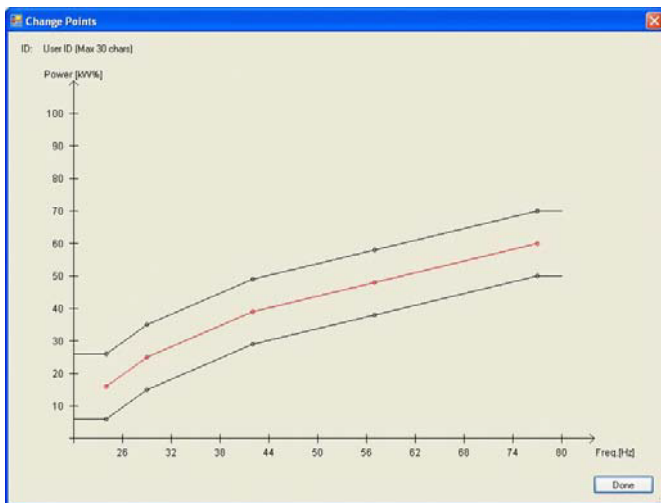

Figure 5.6 Change setpoints

Note that the limits stretch below the lowest frequency and above the highest frequency as flat lines (see figure 5.6). This illustrates the behaviour of the APM, which will have fixed setpoint outside the frequency range; Below the minimum frequency the setpoint equals the setpoint of the lowest point and above the maximum frequency it equals the setpoint of the highest point.

To change the setpoint curves simply place the cursor on one of the points (black) and press the left button on the mouse. Keeping the left button pressed move the point to the desired place and let go. Note that in this process the attached lines will follow and the (power, frequency) values are displayed next to the moving point (see figure 5.7).

As soon as the point is dropped on the new position the values disappear again and the curves are redrawn. A point

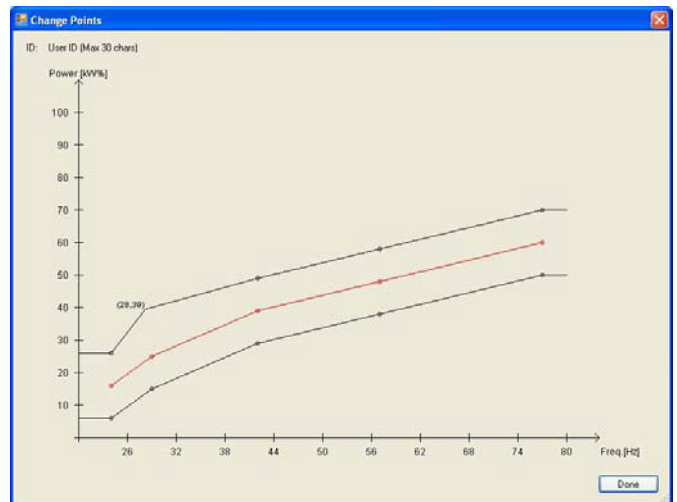

Figure 5.7 Setpoint changed

may be moved anywhere with the following limitations: A point can not be assigned a frequency value smaller than the previous point or larger than the following. I.e. a point can not be moved left of the previous point or right of the next.

A point can not be moved above 100% or below 0%.

To assign frequency dependent response times change the response time for one or more points by placing the mouse on the desired point and press the right button. This produces a small window with the current setting as shown in figure 5.8.

Change the displayed value to the desired value and press Enter. Pressing Escape discards changes and keeps the original value.

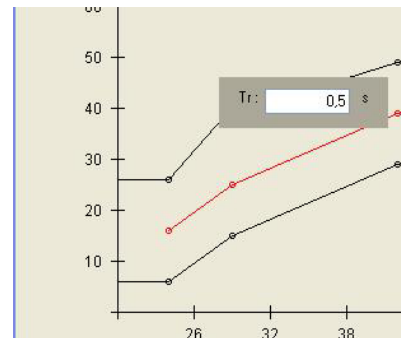

Figure 5.8 Set a speed dependable response time

When all changes to the curve layouts and response times have been made press the „Done“-button to start transferring all parameters to the APM. To keep existing values in the APM and discard changes press Escape. During the transfer process all other communication with the APM or VFDSetup is disabled to prevent loss of data. After completing the transfer an inquiry of the success of the transfer is automatically performed and if no message is given the transfer was successful. Otherwise a warning will be shown telling the user that something went wrong during the transfer.

After a successful transfer the APM is enabled again and supervision is active, which is displayed on the screen as a green „APM active“ message.

5.7.2 New curve (F8)

A supervision curve may be obtained in various ways. Select „New“ from the „Curve“ menu as shown in figure 5.5 or press F8. In the „Start up“ dialogue box (See figure 5.9) the following four approaches are available.

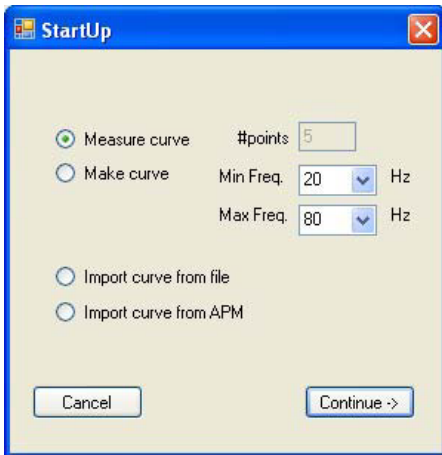

Figure 5.9 Obtain a curve

With reference to the four approaches described earlier, each has the following continuation:

- Measure curve** -> Measure curve
- Make curve** -> Setup setpoints
- Import curve from file** -> Change setpoints
- Import curve from APM** -> Change setpoints

Measure curve

Power- and frequency values are measured and plotted to build a curve adjusted to fit an actual application. This approach is the proper way of designing a curve.

Select the frequency range for the measured values. Values outside this range will be invalid when obtaining and plotting the curve, so be sure to include the whole range at this point.

In the parameters section all necessary functions must be set - most of which may be changed at later if required - only range settings remain unchanged from this point on. See chapter 5.6.1.

At this point in the process supervision in the APM will be disabled, so no alarms will be generated during measuring. This is illustrated with the „APM Inactive“ message in the top right corner of the screen (see figure 5.10). During the whole measuring process the supervision will remain disabled. Upon completion the supervision is automatically enabled again.

The coordinate system used to plot the measurements has the frequency measurements on the x-axis and the power measurements on the y-axis. The frequency axis is limited to the range as requested when selecting the new curve (see figure 5.9) and the power axis always ranges from 0 to 100%. Each measuring pair (frequency, power) is shown with a square, with the current pair in red and all previous in black (see figure 5.10).

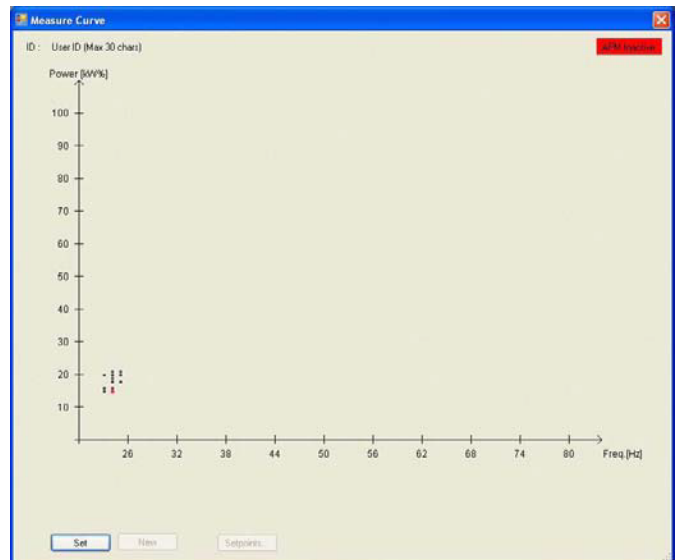

Figure 5.10 Measure curve

When the red dot is steady it is time to save the measurement. This is done by pressing the „Set“ button resulting in a large red dot. A large red dot represents a measurement to be used for the later supervision setpoints. Until the „Set“-button is pressed only visual presentation of measurements is shown. A new value for the current point (large red dot) may be selected by pressing the „Set“-button with the red square in a different position. This procedure may be repeated as many time as required; Pressing the „Set“-button only sets a new measurement pair as the current point.

If the „Set“-button is disabled, either the frequency value or the power value or both are out of range in which case it would be wrong to use the measurement. Most likely the frequency measurement is either too small or too large. Check the position of the red dot and correct if necessary the impressed frequency.

After pressing the „Set“-button and seeing the large red dot appear, also the „New“-button will be enabled (see figure 5.11). When satisfied with the position of the large red dot it is time to proceed with the next point on the measuring

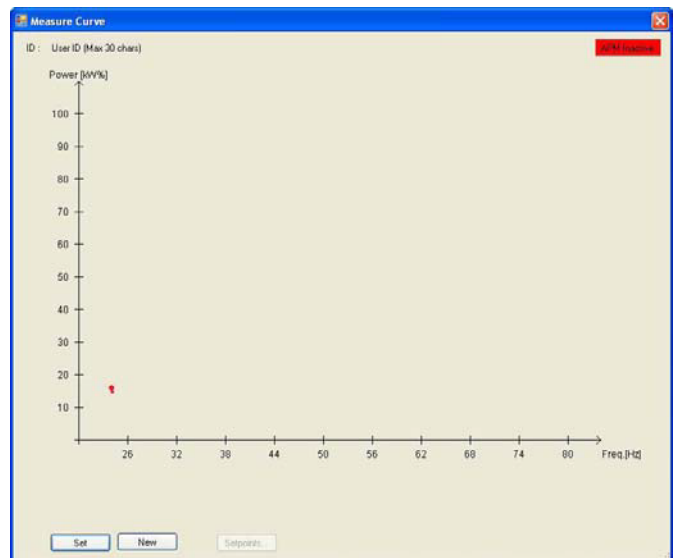

Figure 5.11 Setting a point on the curve

curve. Pressing the „New“-button stores the point (large red dot) and prepares a new. At this point the large red dots are fixed and can not be reassigned new values anymore. Only by discarding this curve and starting over with creating a new curve may these points now be changed.

After pressing the „New“-button change the impressed frequency to the desired value and wait until the red square is steady. Now press the „Set“-button and if satisfied press the „New“-button again.

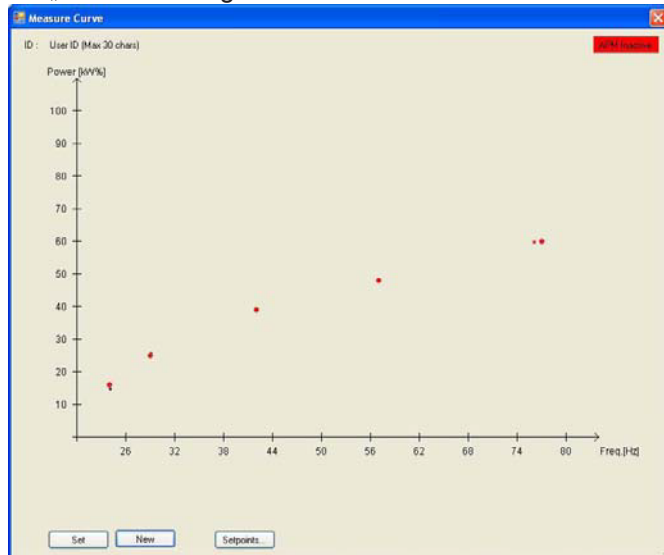

Figure 5.12 Done measuring?

Repeat this procedure until a suitable number of large red dots are present over the whole frequency range as shown in figure 5.12.

Note that the „Setpoints...“-button is now enabled, which means that a number of points (large red dots) between 2 and 10 is present on the screen. The APM450 is designed to handle at least 2 points and no more than 10 points.

Now the measuring process is completed and it is time to make setpoints. Please proceed with paragraph 5.7.1 for an explanation on changing setpoints.

Upon completion of the setting up the programme returns to the main roll window (see chapter 5.9).

Make curve

A curve may also be „obtained“ without having to measure on the actual application. This is done by selecting the „Make curve“ from the Start up dialogue box (see figure 5.5).

Select the number of points for the curve. Note that this number can not be changed when construction has begun, so be sure to include enough points before continuing. Allowed number of points are 2 - 10. Also select the frequency range for the curve. This range is also fixed when construction begins.

In the parameters section all necessary functions must be set - most of which may be changed at later if required - only range settings remain unchanged from this point on. See chapter 5.6.1.

After pressing the „Continue“ button two linear setpoint curves are constructed in the entered frequency range with power values from 10 - 90% as shown in figure 5.13. In this range the setpoints are placed equally, but may be moved to fit the actual application as described in paragraph 5.7.1.

Upon completion of the setting up the programme returns to the main roll window (see chapter 5.9).

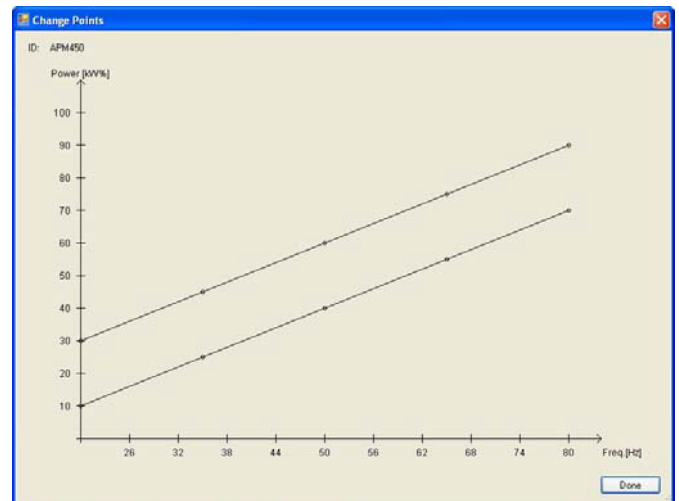

Figure 5.13 Construct a curve

Import from file

In case a curve with corresponding parameters exist on disc, they may be used a basis or exact copy for a new curve.

Selecting this approach opens an „Open File Dialogue box“ to help search for the file where the desired curve is stored.

Upon loading of the file the general settings may be changed (see paragraph 5.6) as well as the fitting of the setpoint values (see paragraph 5.7.1).

Upon completion of the setting up the programme returns to the main roll window (see chapter 5.9).

Import from APM

Be sure to have the APM450 connected and a connection established (see chapter 5.5) before selecting this approach. Press „Continue ->“ and the parameters from the APM are requested. If transmission is succeeded a dialogue box with general settings is shown as described in paragraph 5.6.

Changing the setpoints to fit the application is done as described in paragraph 5.7.1.

Upon completion of the setting up the programme returns to the main roll window (see chapter 5.9).

5.7.3 Stop at alarm (F9)

The roll curve may be paused automatically if an alarm occurs in the APM. The curve will roll for about 5 seconds and then stop. To restart rolling press the „Pause“-key.

5.8 About

The „About“ menu entry gives information on the revision of

the VFDSetup software. Please make sure that always the newest revision is used - see the manufacturer's website www.unipower.dk for information on the most recent version.

5.9 The main window

The main window consists of a drawing area and a menu, which will both be described in the following paragraphs. Also invoked keyboard commands will be described later in the chapter.

5.9.1 Roll window

The roll window displays a roll curve representing the last 1 minute of measurements as well as the frequency dependent setpoints for the max- and min limit (see figure 5.14). Above the roll curve the real time values for both the power and frequency measurements are shown as well as the ID for the APM parameters presently in use. Also alarms are shown in red text if present. After resetting an alarm the text will disappear again. In the upper right corner the

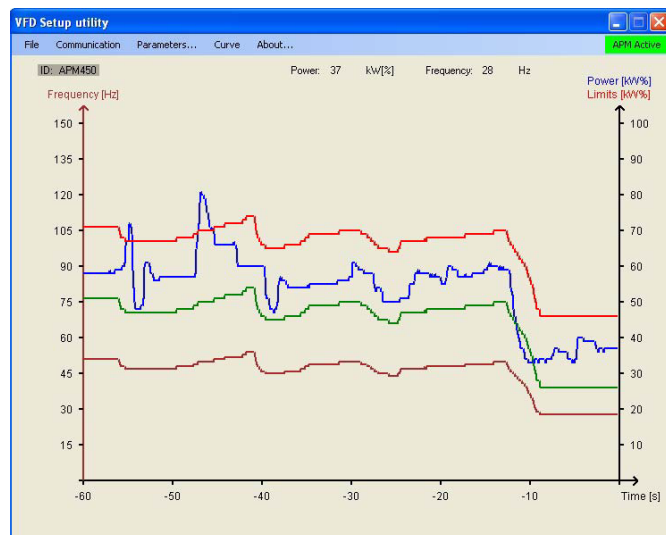

Figure 5.14 Roll window status of the supervision is shown.

The blue curve represents the power measurements, the brown curve the frequency measurements and the red and green curves represent the frequency adjusted max.- and min. limit respectively. Grey parts of the limit curves indicate that the limits have been inactive for this time. If the measured load (power) lies below the activation threshold of 5% the limits will be shown in violet. Power values below 3% are shown as 0%.

Enabling/Disabling the supervision can be done in the VFDSetup software by pressing the button in the upper right corner. With the supervision enabled the button reads „APM Active“ in green - otherwise „APM Inactive“ will be displayed in red.

If the digital inputs on the APM450 used for blocking of alarms are activated this will also cause the limit curves to be drawn in grey. Also the start timer will be shown as grey limit curves.

5.9.2 Menu

The menu provides the user with features as shown in figure 5.15. All features are described in previous sections so only the menu is shown here. Please refer to the sections for an explanation.

5.10 Keyboard commands

When using the roll window and curve window a couple of keyboard commands are invoked into the programme. These will not be visible from any of the menus and are only available when the roll window is in front.

„Space“: Pressing the „Space“-bar sends a reset to the APM and may be used to reset possible alarms in the unit. If no alarm is present the command will have no function.

„Pause“: If something needs a more thorough analysis the roll window may be paused at any time - not only after an alarm as described in paragraph 5.7.3. Pressing the „Pause“-key will stop the roll immediately. To make it roll again repress the „Pause“-key.

„S“: During measuring a new curve pressing the key „S“ will have the same effect as pressing the „Set“ button: The point (frequency, power) is saved as a point on the curve.

„N“: Same function as pressing the „New“ button: A new point may be obtained and the previous is saved.

„Alt+X“: Shutting down the programme.

5.11 Shortcuts

- F2 Save parameters on disc.
- F7 Modify curve on working APM
- F8 Create new curve
- F9 Toggle Stop at alarm

5.12 Error messages

The following list of error messages may occur during the use of VFDSetup. The error message is shown in red. The corresponding explanation is shown in black.

APM450 not found on any port

During Auto connect no APM450 has been detected. Try again or check the communication

Comx does not exist.

Please select another COM-port.

COMx is not enumerated in the operating system

Comx occupied!

Please select another COM-port

COMx used by another application

ID too long - Max 30 chars!

ID text string may not exceed 30 characters

kWh count not reset!

Reset of kWh count could not be performed

No valid setpoints.

Please select another entry point from the 'new curve' menu!

Curve data in the APM450 not valid as basis for new curve.
Select another way of creating a new curve.

P1Max too high for this voltage range!

Requested current range exceeds the maximum internal current range in APM450. Enter a smaller kW range.

P1Max too low!

The dynamic zoom (digital) is less than 40% of the range.
Will only occur for very small kW ranges – current range 1A.

Parameters not received correctly!

Incomplete telegram received – try again or check communication.

Parameters not transferred correctly!

Checksum error on received parameter set.

Timeout on receiving parameters!

A PC-request for parameters from APM450 has taken too long - try again or check the communication.